

SafetyCast™ 80 Virtual Sign Projector Datasheet

For information about the other products in the SafetyCast product family visit, [Order Online Now](#) or [Request Quote](#):

www.laserglow.com/product/byapplication/SafetyCast-Virtual-Sign-Projector/



Overview:

The SafetyCast™ 80 Virtual Sign Projectors are the ideal way to display bright floor and wall safety signs in locations where there is high traffic, potential for a hazard, or uneven floors. The SafetyCast™ 80 Virtual Sign Projector uses an image lens and a high-output LED bulb to project a clear sign at distances of up to 50 m (165'). The SafetyCast™ 80 Virtual Sign Projector works well in almost all lighting conditions and is easy to mount and adjust. Once installed, there's virtually no maintenance, and you won't need to worry about replacing damaged signs on your floors or walls.

Key Features:

- High-contrast image projection
- Powerful close-range and long-range projection
- Interchangeable image lenses
- Minimal maintenance – low total cost of ownership
- A large variety of safety signage

Specifications:

Lamp Details

Type of Light Source:	High Performance LED
Light Source Life (MTTF):	30,000 hours at 25°C/77°F

Optical

Light Colour Temperature:	6,000 K
Luminous Flux:	12,000 lm
Projection Distance:	Up to 165 ft (50 m) in dark ambient lighting
Beam Projection Lens Angles:	Extra Narrow: f=200mm / 15° Medium: f=115mm / 25°

Temperature Range:	2°C to 50°C (35 to 120 °F)
Storage Temperature Range:	-10 to 50°C (15 to 120 °F)
Relative humidity:	5% to 80% noncondensing
IP Rating:	IP55
Projector Power:	80W
Power Supply (included):	100-240 VAC nominal, 50/60 Hz, 0.67A, 80W

Standard Warranty:	12 months
---------------------------	-----------

Smart Triggered Projection:	Projection flashing using either Motion Sensors or Break of Beam sensors
------------------------------------	--

SafetyCast™ 80 Virtual Sign Projector

Product Series

Lens Angle

F = Extra Narrow Angle (13°)

SKU Guide - HSV 8 F 063 X

Power

8 = 80W 

Type

X = Fan Cooled 





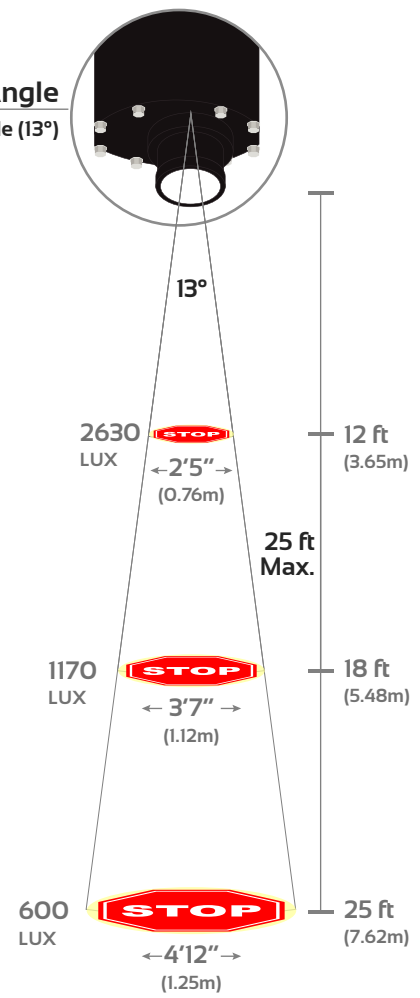











Image Type

Projection	80W	Projection	80W	Projection	80W
	064		097		109
	063		062		107
	099		076		115
	066		075		119
	100		077		117
	065		111		CUS
	098		113		



Accessories:

The most popular accessories for model HSV8___X are shown below. For additional details regarding these or other accessories please see our website or contact us directly.

Product SKU	Description	Product SKU	Description	Product SKU	Description
Smart Trigger Kits / Sensors			Sensors / Cables / Mounting Hardware		
 STB080XXX	Smart Trigger Basic Control Kit (Single Input and Output)	 SENPBKXXX	Momentary Push Button Sensor Kit	 AOO08015T	Lens Only - 80 W 15° Fan Cooled
 HSCCTRLAX	Smart Trigger Pro Control Kit (Multiple Inputs and/or Outputs)	 STBSIGC2X	Signal Cable Extension (2m)	 AOO08025T	Lens Only - 80 W 25° Fan Cooled
 HSCRLY8PX	Signal Relay Box for Multiple Projectors	 STBSIGC5X	Signal Cable Extension (5m)	 AOG___XXY	Image Template Only
 SENIMKXXX	Indoor Motion Sensor Kit	 STBSENC2X	Sensor Cable Extension (2m)		
 SENMADPTX	4 Motion Sensor Input Adapter	 STBSENC5X	Sensor Cable Extension (5m)		
 SENB03KXX	Retroreflective Beam Break Sensor Kit (3m range)	 ABM088CXX	No Drill Magnetic Mounts		
 SENB30KXX	Retroreflective Beam Break Sensor Kit (30m range)				



Find out more about Accessories:
www.laserglow.com/industrial

SafetyCast™ 80 Virtual Sign Projector

Projector dimensions:

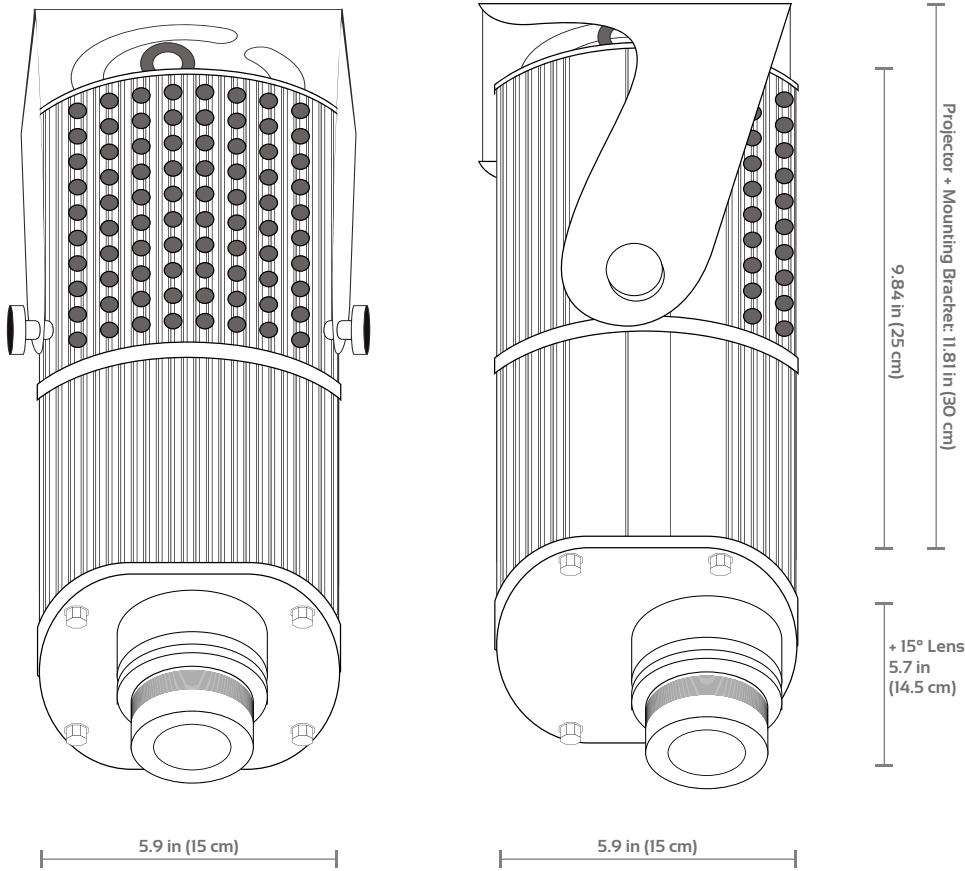

Box Dimensions	Weight
23.6 x 8.26 x 8.26 in (60 x 21 x 21 cm)	17.5 lb (8 Kg)

Power Supply dimensions:

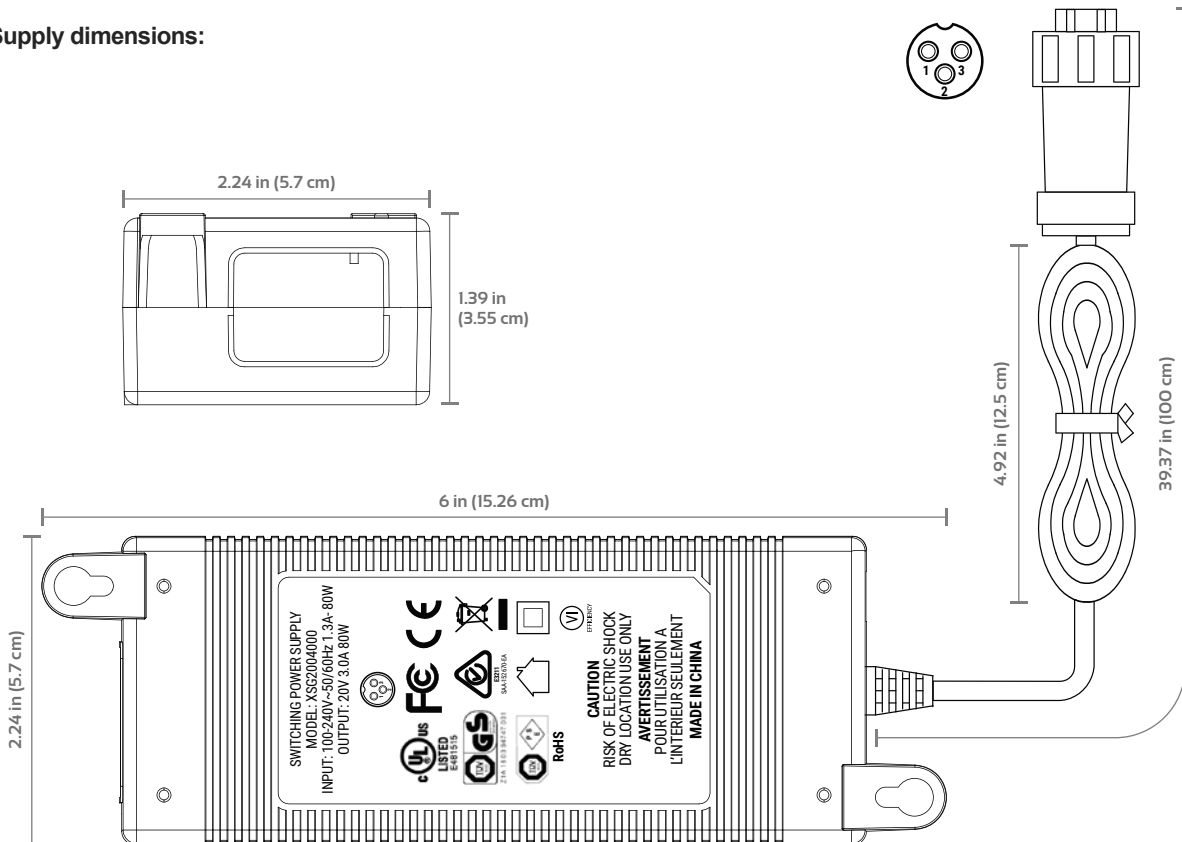



www.laserglow.com

For more information please contact:

LASERGLOW TECHNOLOGIES

99 Ingram Dr. Unit B, North York, ON, Canada M6M2L7

Tel. (416) 729-7976 Fax (480) 247-4864

sales@laserglow.com

E&OE: Data included in this sheet may be subject to change without notice.
Please confirm critical specifications with our staff prior to ordering.