

Laserglow Product Datasheet

Dockline

Laserglow Part Number: HDLG40XXX

Similar Products:

For information about the other lasers in this product family visit:

<http://www.laserglow.com/HDL>

Ordering:

Order Online Now or Request Quote:

<http://www.laserglow.com/HDLG40XXX>



Overview:

The Dockline System is the perfect truck and trailer docking assistant. These provide the driver with clear, visible indicators to assist in dock approach, reduce docking time, cargo damage and reduce possible injury to dock handlers.

Key Features:

- *Output Power:* 20/40 mW
- *Fan Angle:* 30°
- *Expected Life:* 3000-5000 hours
- *Water Resistant:* IP68
- *Projection Type:* Line
- *Mounting:* Multiple 1/4-20 and M4 mounting points
- *Key Feature:* Projects highly visible red or green lines for high visibility applications.
- *Package Includes:* Laser (focused to infinity) mounted into enclosure with bracket

The Hazard Safety Projection Series was developed to address the safety concerns in warehouses, dock and loading areas, or any industrial workplace area where heavy mobile equipment shares workspace with pedestrians. These products were researched and developed by Laserglow in conjunction with some of the leading lighting manufacturers in the industry. Some of the products in this series are also ideal guidance systems for dock approach, load stacking and off-loading.

Specifications:

This spec sheet has been generated specifically for part number HDLG40XXX, per your request, and data for the entire series is also displayed for your reference. The specs which are specific to HDLG40XXX have been highlighted below in **red + bold**.

Laser Form Factor	B9
Output Power (mW)	40
IEC Safety Class	3R
Projection Type (See below for detail)	Line
Projection Fan Angle (°, full angle)	50, 100
Divergence (mrad, full angle)	<0.3
Beam Dimensions (mm, 1/e ²)	7
IP rating	67
Max. TTL Modulation Freq. (Hz)	500
Modulation Input Signal	0-5 VDC
Max. Power Input Duty Cycle	100
Cooling Method	Passive Air
Standard Warranty (months)	6
MTTF (operational hours)	10000
Weight of Product or Laser Head (kg)	0.26
Dimensions of Product or Laser Head (mm)	68 (l) x 20 (d)
Power Supply	3-6 VDC input

CW: All specifications are based on performance at full output power and after the specified warmup period. Output characteristics may change if the laser is run at a different power level.

Q-Switched: Specifications are based on the laser pulsing at the specified design frequency. Output characteristics may change if the laser is run at a different frequency.

Regulatory Classification:

The model you have selected (HDLG40XXX) requires the following safety label(s):

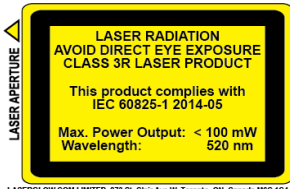

LASERLOW.COM LIMITED, 873 St. Clair Ave W, Toronto, ON, Canada M6C 1C4

Dimensional Drawing - Laser Form Factor: B9:



Remove front cap to
access focus adjustment

Focus Adjustment
Locking Set Screw

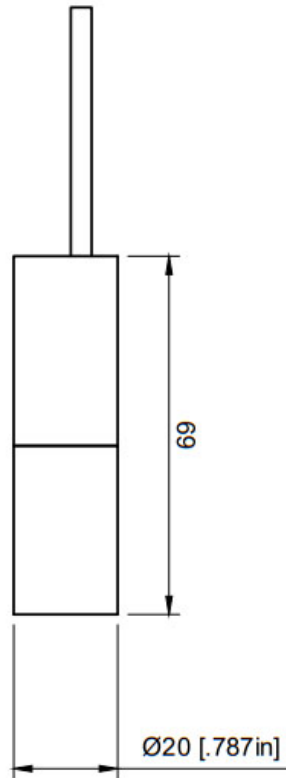
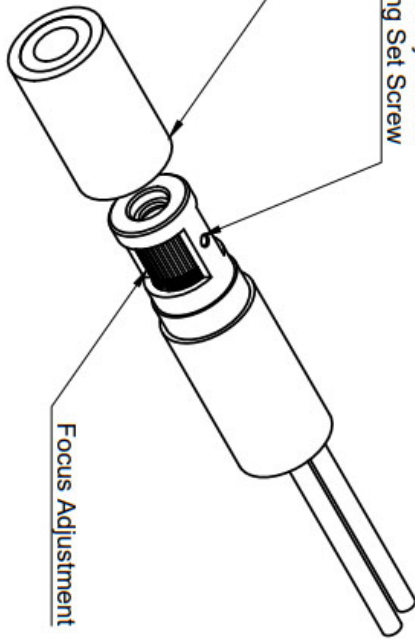

Title
Brightline Premium







Laserglow Technologies

Dimensions are in mm [inch]

Rev.
The information contained in this drawing is the sole property of Laserglow Technologies. Any reproduction in part or as a whole without the written permission of Laserglow Technologies is Prohibited.

Accessories:

The most popular accessories for model HDLG40XXX are shown below. For additional details regarding these or other accessories please see our website or contact us directly.

Part Number	Description	
 ABB000XXX	ABB-standard Brightline Standard Mounting Bracket . Full Details: www.laserglow.com/ABB	
 ABF05A3WX	ABF-N.American Brightline Premium 5V Power Supply (80-260 VAC, N. American plug) 3A w/WP connector For Brightline Premium Only . Full Details: www.laserglow.com/ABF	
 ADB002XXX	ADB-deluxe Brightline Deluxe Mounting Bracket V2 . Full Details: www.laserglow.com/ADB	
 ADB002XXX	ADB-deluxe Brightline Deluxe Mounting Bracket V2 . Full Details: www.laserglow.com/ADB	
 AMMA00XXX	AMA-Mounting Arm Articulating Mounting Arm 1/4-20 thread . Full Details: www.laserglow.com/AMM	
 HSTCRMIXX	Smart Trigger kit with Indoor Motion Detection Sensor . Full Details: www.laserglow.com/HST	

FOR MORE INFORMATION PLEASE CONTACT:

LASERGLOW TECHNOLOGIES
99 Ingram Dr. Unit B, North York, ON, Canada M6M2L7
Tel. (416) 729-7976 Fax (716) 322-3510
sales@laserglow.com www.laserglow.com

E&OE: Data included in this sheet may be subject to change without notice.

Please confirm critical specifications with our staff prior to ordering.